

# DENY

## M&T | Lever Handle







Finish Shown: Antique Brass (Ms-A)

**Material** Handle: Solid Brass  
Rosette: Magnetic  
Stainless Steel





**Dimension for Application** Recommended door thickness: 38.5 - 44mm. Options for door thickness 38-126mm is available.

**12 Finishes**

Matt Nickel	SNi	
Glossy Chrome	Cr	
Black Chrome	Cr-K	
Stainless Steel	NRz	
Matt Black   K-Industrial		



**Door preparation:** Drilling a Ø 24-25mm hole.

Titanium / PVD Finishes

Black	TiN-K	
Brushed Brass	TiN-A	
Gunmetal	TiN-C	
Light Bronze	TiN-B	

**Magnetic Rosette** Handles with magnetic rosettes can be fully inserted into the door, be careful of the weakened side of the rebated and reversed doors. **Thickness of the magnetic rosettes is 5 mm.**

Brass Finishes

Natural Brass	Ms	
Polished Brass	Ms-L	
Antique Brass	Ms-A	

The space/depth of insertion for the magnetic rosette including the returned spring and handle neck is **8.5 mm**.

**Warranty** Mechanics: **3 years**  
SNi, Cr: **3 years**  
Titanium: **15 years**  
Brass: **Lifetime**

**Mounting** Bolt-Through Fixing

## NON-MAGNETIC

Available in a choice of **8 finishes** with a **guarantee of 3-15 years** depending on the finish. Suitable for interior and exterior doors. Round & square non-magnetic rose comes in **depths of 7mm**.

### MANUFACTORY MECHANICS M 2000



Mechanics of the non-magnetic rose

Mechanics M 2000 - designed, manufactured and assembled at M&T - with own patented slip system which prevents bending and cracking the door in lock area. Simple and fast assembly.

### MANUFACTORY MECHANICS M 2004



Mechanics of the non-magnetic rose

Mechanics M 2004 – designed, manufactured, and assembled at M&T – with own patented slip system which prevents bending and cracking in the door in lock area. Simple and fast assembly.

## MAGNETIC

Available in a choice of **10 finishes** with a **guarantee of 8-15 years** depending on the finish. Suitable for interior and exterior doors. Round & square magnetic rose comes in **depths of 5mm**.

### MANUFACTORY MECHANICS M 2018



Mechanics of the magnetic rose

Designed, manufactured and assembled in M&T – with its own patent of the rosette using neodymium magnets and a system of returned springs.

Round Rose



Square Rose



## NON-MAGNETIC

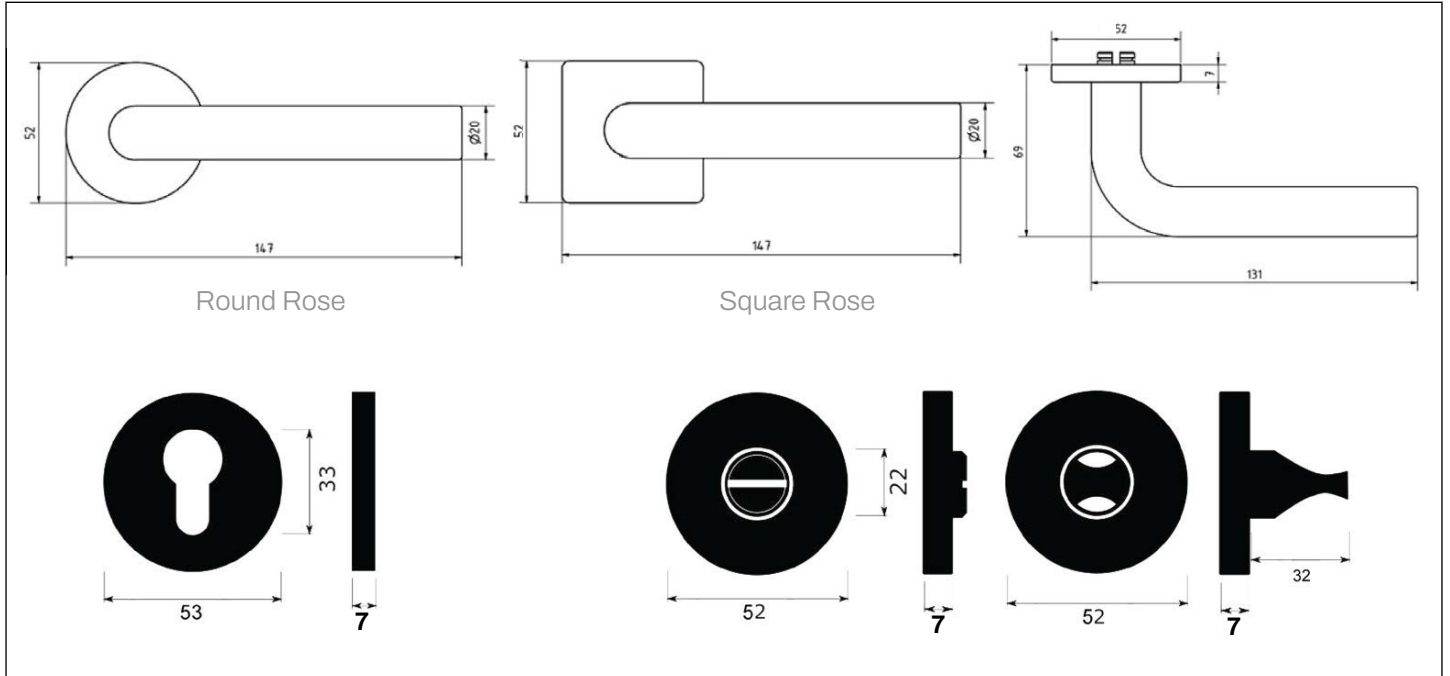

## MAGNETIC

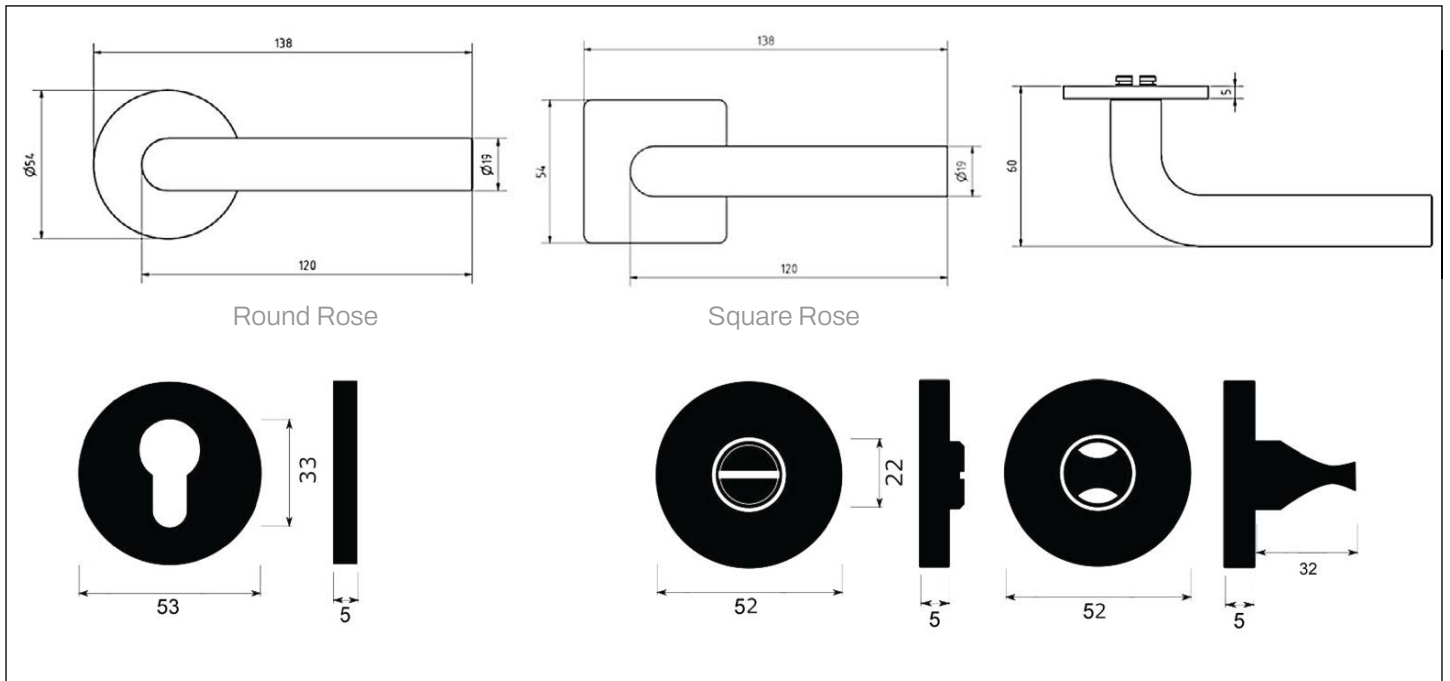

Two Tease offers a range of lock options for handles.  
Click on the boxes to see more information.

---

### AGB LOCKS



[Click Here](#)

### TUBULAR LATCH & PRIVACY BOLTS



[Click Here](#)

## Titanium Finish

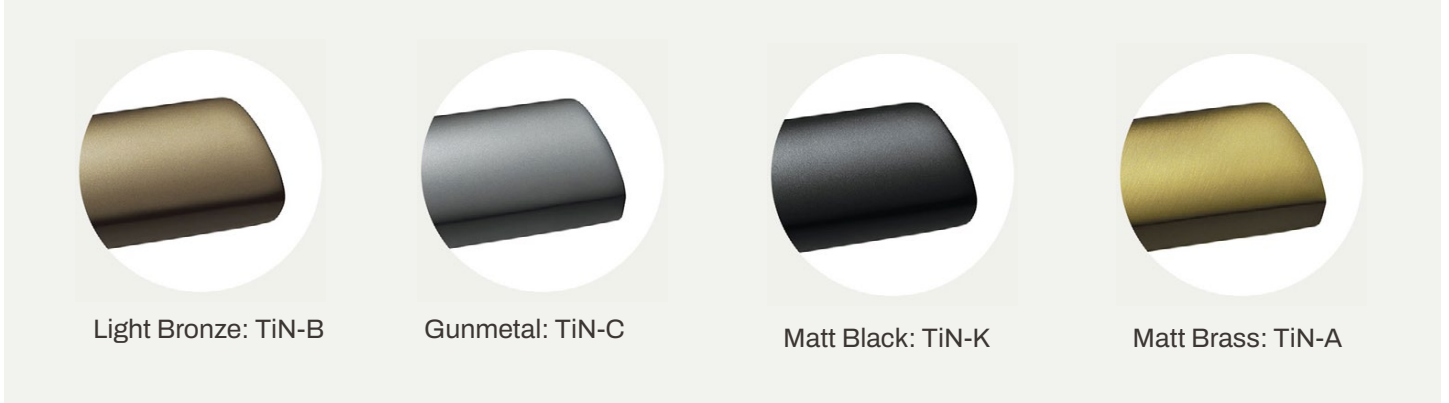

The surface of the door handles and labels M&T is coated with a hard, chemically stable film using methods PVD and PACVD. This technological process is done under lower pressure in vacuum chambers. In the PACVD (Plasma Assisted Chemical Vapour Deposition) process, the coating grows due to heterogeneous chemical reaction on the surface of the substrate.

necessary for the chemical reaction so the reaction temperature can be lower. Moreover, the properties of the growing layer can be controlled by the variation of the plasma parameters. In the PVD (Physical Vapour Deposition) process, the coating grows due to deposition of atoms coming from a solid-state target plate in the vacuum recipient walls.

The reaction substances are supplied in the gas phase. These gases are activated in low temperatures plasma where molecules are dissociated and radicals, ions and excited atoms arise. It decreases the activation energy

## Advantages

A thin layer of 2 microns has several advantages, which makes it so exceptional:

- The extraordinary hardness** 7 times harder than handles with a protective baked enamel
- High resistance to abrasion and scratching** Cannot be damaged/ scratched with normal use
- Colours and chemical stability** The surface even after many years has the same colour
- Corrosion** Quality applied coatings are only slightly microporous, which prevents the penetration of small particles to material of handle and thus the formation of corrosion.

## Brass Finishes

- Internal and external use
- Anti-microbial
- Maintenance Free - cotton or micro fibre use
- Lead time: 10 weeks
- Lifetime guarantee for brass



**Natural Brass (MS)**

Mechanically treated surface on a brass product with a soft texture and colours. The surface ages naturally and the colour changes in according to the weather conditions and climatic conditions.



**Polished Brass (Ms-L)**

Mechanically polished brass surface with a high gloss finish which will gradually patina. Surface gets naturally old and changes colour and appearance according to frequency of use on a brass product with the effect of several years use providing an aged finish. The brass has a combination of lighter and darker shades, and the surface will naturally age and change its colour according to the climatic conditions.



**Antique Brass (Ms-A)**

Mechanically modified surface on a brass product with the effect of several years use providing an aged finish. The brass has a combination of lighter and darker shades, and the surface will naturally age and change its colour according to the climatic conditions.

## Other Finishes

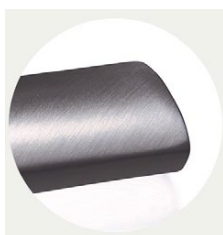

NRz: Stainless Steel



Industrial K: Mat Black



Cr: Glossy Chrome

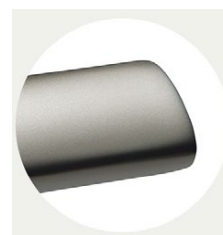

SNI: Matt Nickel



Cr-K: Chrome Black