

# BASICS LEVER (LB7)

## FORMANI



Shown Above: LB7-19 | PVD Satin Gold (IM)

### Lever Handle

<b>LB7-19</b>	Code
Ø 19mm lever, 135mm long sprung on a round rose	1501D150IMXX0
<b>LB7-19BSQ</b>	
Lever sprung on a square rose	1501D250IMXX0BS

### Escutcheons





<b>LBY50</b>	
Round Key Escutcheons	1501Y002IMXX0
<b>BSQY53</b>	
Square Key Escutcheons	1501Y060IMXX0















### Doorstop

<b>LB10</b>	
Ø 39, 40 (H) floor mounted doorstop	1501Z028IMXX0















>>More finishes available on the next page.

### Privacy

<b>LBWC50</b>	Code
Round turn and release privacy set including 5/6/7/8mm pin with indication.	1501T020IMXXU
	
<b>LBWC50-ZI</b>	
Round turn and release privacy set including 5/6/7/8mm pin without indication.	1501T020IMXXUZI
	
<b>LBWC50</b>	
Square turn and release privacy set including 5/6/7/8mm pin with indication.	1501T060IMXXU
	
<b>LBWC50-ZI</b>	
Square turn and release privacy set including 5/6/7/8mm pin without indication.	1501T060IMXXUZI
	

	LB7-19	LBWC50	LBY50	LB10
<b>Available Finishes</b>	<b>Door Handle</b>	<b>Privacy</b> ZI = Without Indicator	<b>Key Escutcheon</b>	<b>Doorstop</b>
<b>Satin Stainless Steel   IN</b>	 1501D150INXX0	 1501T020INXXU 1501T020INXXUZI	 1501Y002INXX0	 1501Z028INXX0
<b>Satin Black   NM</b>	 1501D150NMXX0	 1501T020NMXXU 1501T020NMXXUZI	 1501Y002NMXX0	 1501Z028NMXX0
<b>PVD Gunmetal   IG</b>	 1501D150IGXX0	 1501T020IGXXU 1501T020IGXXUZI	 1501Y002IGXX0	 1501Z028IGXX0
<b>PVD Satin Gold   IM</b>	 1501D150IMXX0	 1501T020IMXXU 1501T020IMXXUZI	 1501Y002IMXX0	 1501Z028IMXX0
<b>PVD Polished Copper   IK</b>	 1501D150IKXX0	 1501T020IKXXU 1501T020IKXXUZI	 1501Y002IKXX0	 1501Z028IKXX0
<b>Satin White   BM</b>	 1501D142BMXX0	 1501T020BMXXU 1501T020BMXXUZI	Image unavailable 1501Y002BMXX0	 1501Z028BRXX0

**LB7-19BSQ**

	<b>LB7-19BSQ</b>	<b>BSQWC53</b>	<b>BSQY53</b>
<b>Available Finishes</b>	<b>Door Handle</b>	<b>Privacy</b> ZI = Without Indicator	<b>Key Escutcheon</b>
<b>Satin Stainless Steel   IN</b>	 1501D250INXX0BS	 1501T060INXXU 1501T060INXXUZI	 1501Y060INXX0
<b>Satin Black   NM</b>	 1501D250NMXX0BS	 1501T060NMXXU 1501T060NMXXUZI	 1501Y060NMXX0
<b>PVD Gunmetal   IG</b>	 1501D250IGXX0BS	 1501T060IGXXU 1501T060IGXXUZI	 1501Y060IGXX0
<b>PVD Satin Gold   IM</b>	 1501D250IMXX0BS	 1501T060IMXXU 1501T060IMXXUZI	 1501Y060IMXX0
<b>Bronze   BR</b>	 1501D250BRXX0BS	 1501T060BRXXU 1501T060BRXXUZI	 1501Y060BRXX0

## CLASSIFICATION

3	7	-	B	0	3	0	B
---	---	---	---	---	---	---	---

Code can be broken down into the following grade/ digits:

**1. CATEGORY OF USE [3]**

High frequency of use by public or others with little incentive to exercise care and with a high chance of misuse, e.g. public office doors. *Hollow handle.*

**2. DURABILITY [7]**

200,000 cycles

**3. TEST DOOR MASS [-]**

No Classification

**4. FIRE RESISTANCE [B]**

Suitable for use on fire/smoke door assemblies (tested with 200,000 test cycles)

**5. SAFETY [0]**

Normal use

**6. CORROSION RESISTANCE [3]**

High Resistance – 96 hours of salt spray test

**7. SECURITY [0]**

Not suitable for burglary resistant doors

**8. TYPE OF OPERATION [B]**

Spring Loaded levers

[View more info on FORMANI classifications](#)

## DRAWINGS

LB7-19

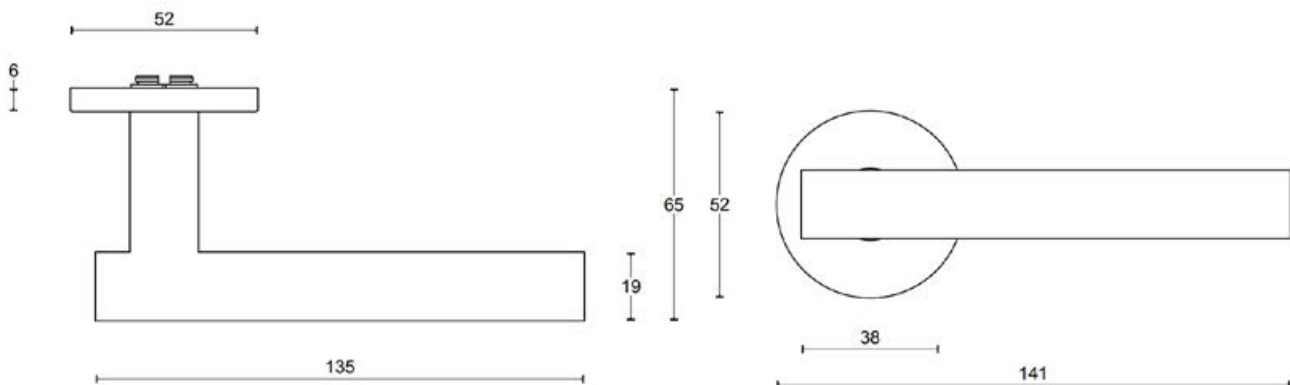

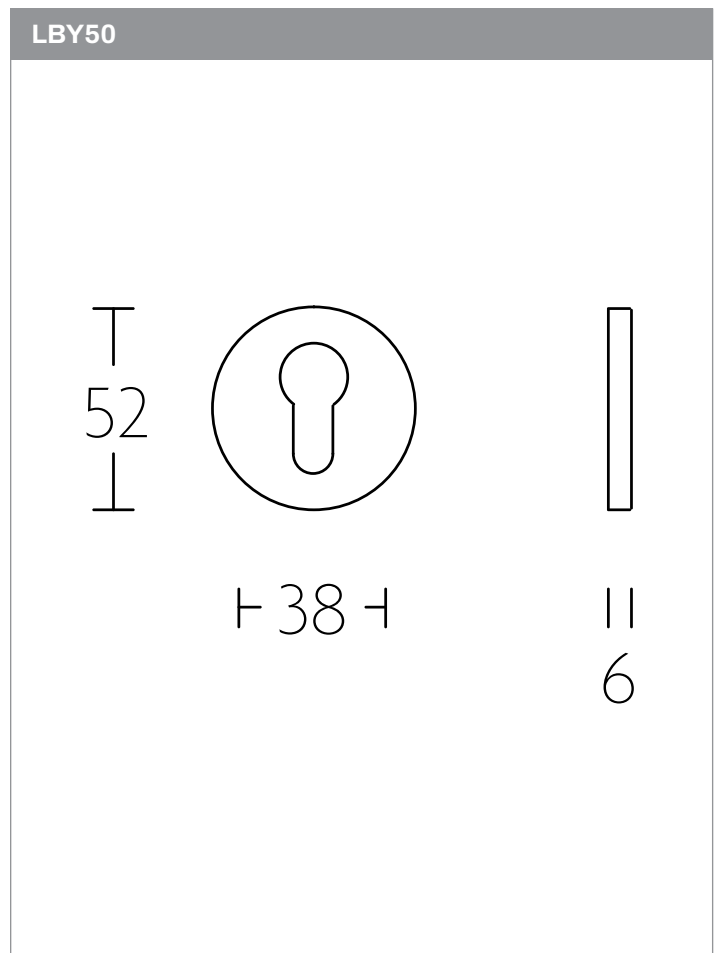
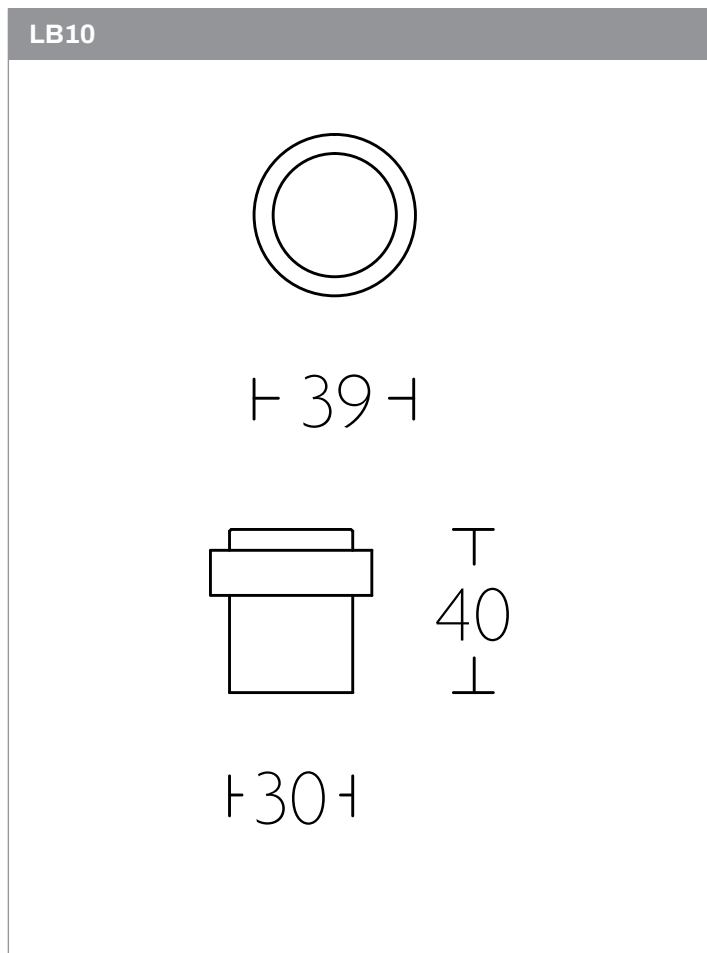
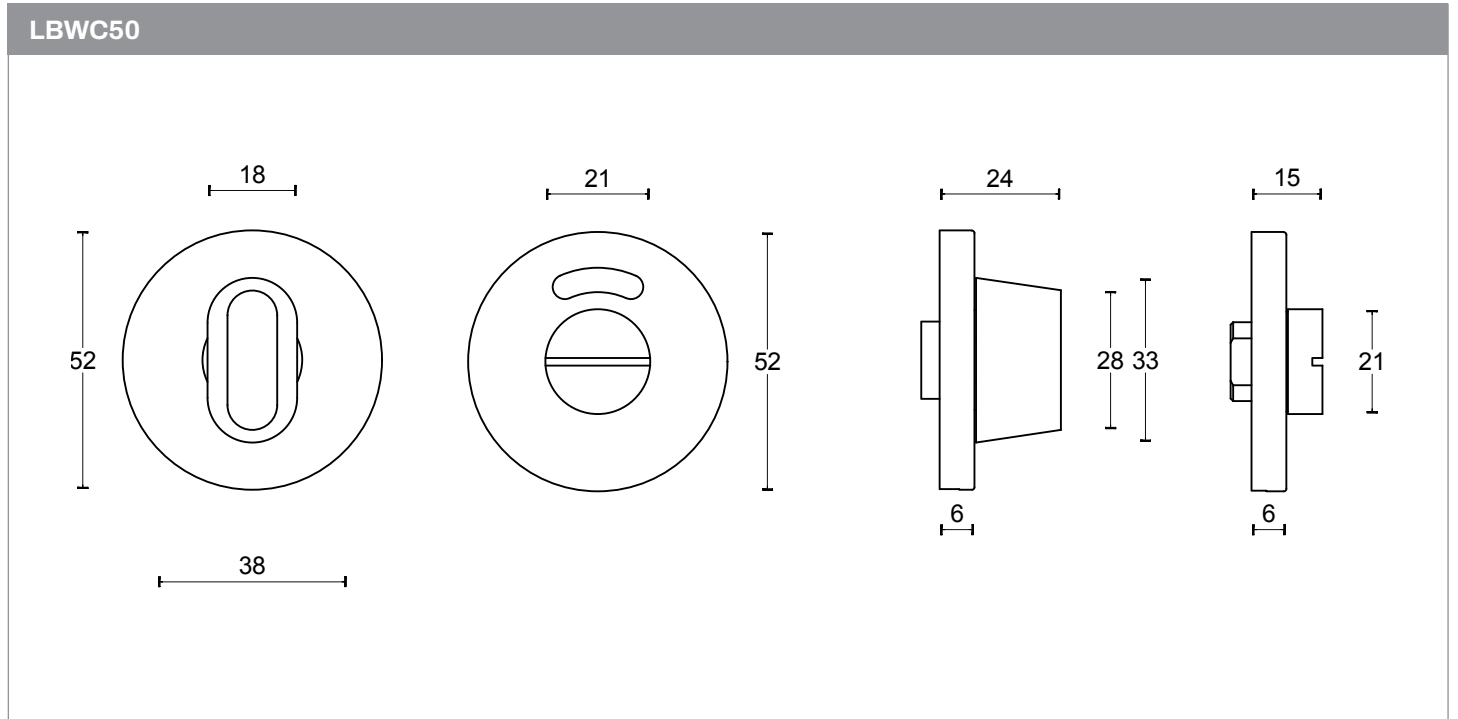

Two Tease offers a range of lock options for handles.  
Click on the boxes to see more information.

---

### AGB LOCKS



[Click Here](#)

### TUBULAR LATCH & PRIVACY BOLTS



[Click Here](#)