

BASICS LEVER (LB20)













FORMANI



Shown Above: LB20 - PVD Satin Gold (IM)

	Lever Handle	Code
	LB20 Ø 19mm lever, 121mm long sprung on a round rose	1501D203IMXX0
	Privacy	
	LBWC50 Round turn and release privacy set including 5/6/7/8mm pin with indication.	1501T020IMXXU
	LBWC50-ZI Round turn and release privacy set including 5/6/7/8mm pin without indication.	1501T020IMXXUZI
	Escutcheons	
	LBY50 Round Key Escutcheons	1501Y002IMXX0
	Doorstop	
	LB10 Ø 39, 40 (H) floor mounted doorstop	1501Z028IMXX0

More finishes available on the next page.

	LB20	LBWC50	LBY50	LB10
Available Finishes	Door Handle	Privacy ZI = Without Indicator	Key Escutcheon	Doorstop
Satin Stainless Steel IN	 1501D203INXX0	 1501T020INXXU 1501T020INXXUZI	 1501Y002INXX0	 1501Z028INXX0
Satin Black NM	 1501D203NMXX0	 1501T020NMXXU 1501T020NMXXUZI	 1501Y002NMXX0	 1501Z028NMXX0
PVD Satin Gold IM	 1501D203IMXX0	 1501T020IMXXU 1501T020IMXXUZI	 1501Y002IMXX0	 1501Z028IMXX0

CLASSIFICATION

HOLLOW HANDLE
According to EN 1906: 2012

3	7	-	B	0	3	0	B
---	---	---	---	---	---	---	---

Code can be broken down into the following grade/ digits:

1. CATEGORY OF USE [3]

High frequency of use by public or others with little incentive to exercise care and with a high chance of misuse, e.g. public office doors. *Hollow handle.*

2. DURABILITY [7]

200,000 cycles

3. TEST DOOR MASS [-]

No Classification

4. FIRE RESISTANCE [B]

Suitable for use on fire/smoke door assemblies (tested with 200,000 test cycles)

5. SAFETY [0]

Normal use

6. CORROSION RESISTANCE [3]

High Resistance – 96 hours of salt spray test

7. SECURITY [0]

Not suitable for burglary resistant doors

8. TYPE OF OPERATION [B]

Spring Loaded levers

[View more info on FORMANI classifications](#)

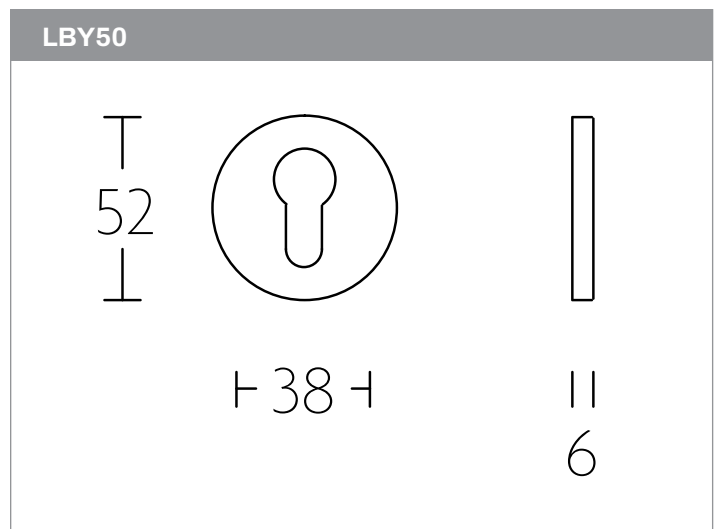
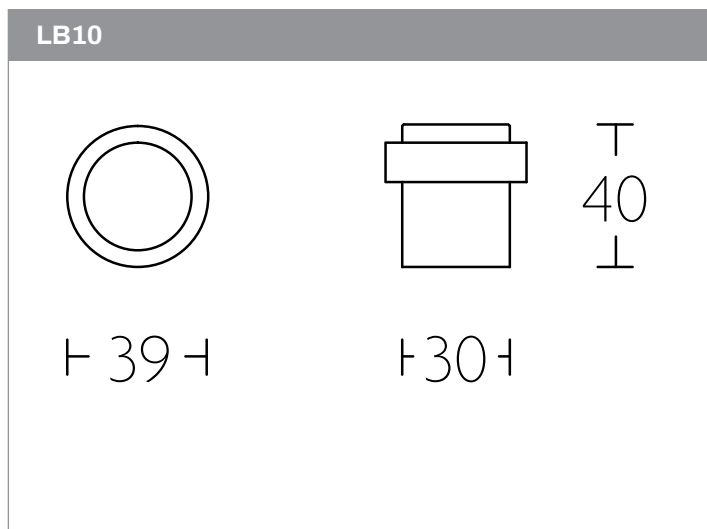
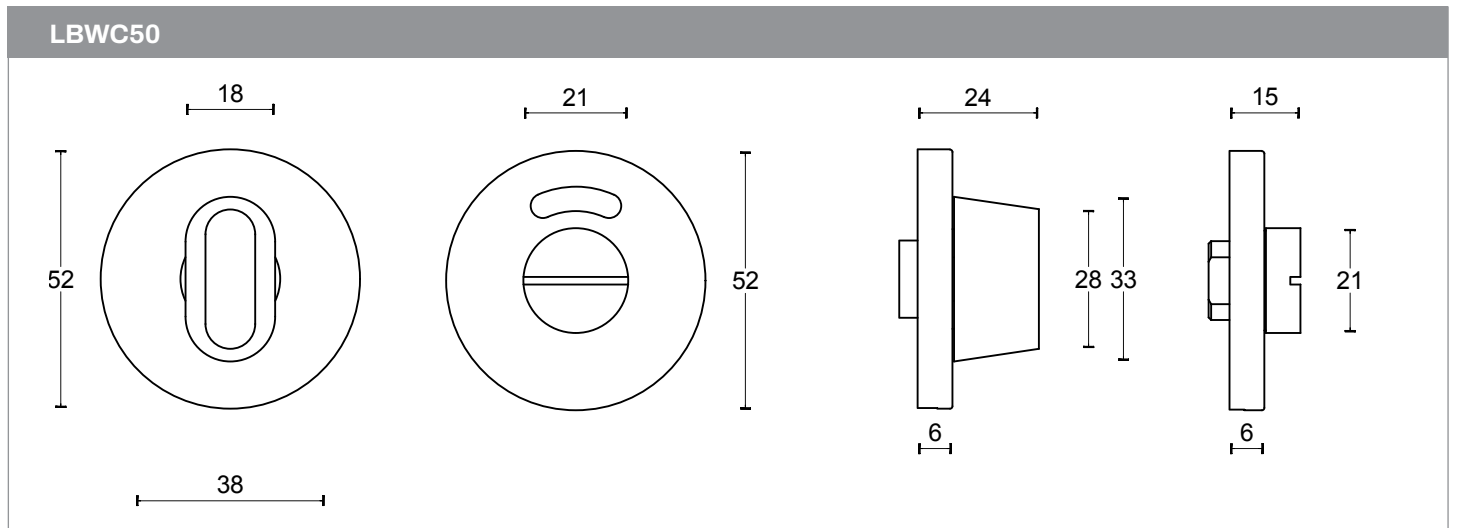
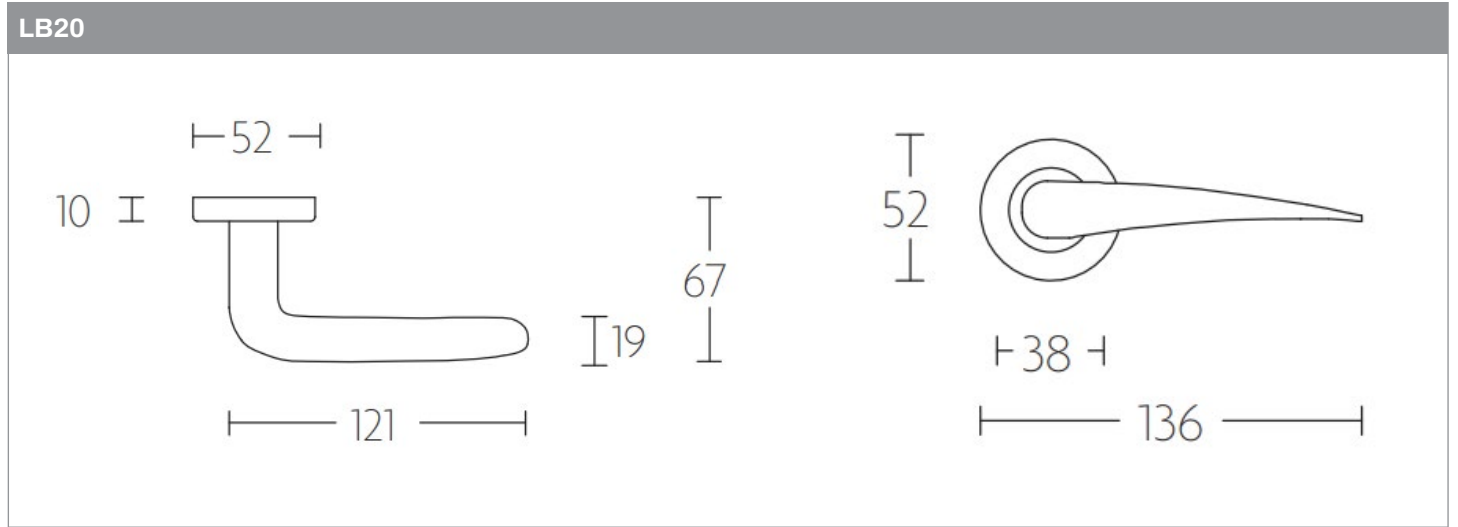

Two Tease offers a range of lock options for handles.
Click on the boxes to see more information.

AGB LOCKS



[Click Here](#)

TUBULAR LATCH & PRIVACY BOLTS



[Click Here](#)