

Specifications details

VERVE LEVER

JOLIE | Jolie Design



Shown above: Aged Bronze

Material	Sand-Casted Solid Brass	J-1250	Lever Handle (W) 18mm x (L)100mm 42 mm ² rose Spring Loaded
Available Finishes	Aged Bronze Satin Black Old Silver Aged Gold	J-7012	Privacy Set 52mm ² round
		J-7027	Key Escutcheon 52mm ² round x (H) 7.5mm

AVAILABLE FINISHES

AGED GOLD | GA



J-1250-GA

J-7012

PRIVACY

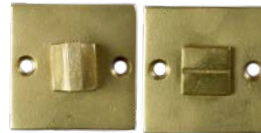

J-7012-GA

J-7027

KEY ESCUTCHEON



J-7027-GA

BLACK | BK



J-1250-BK



J-7012-BK



J-7027-BK

OLD SILVER | OS



J-1250-OS



J-7012-OS



J-7027-OS

AGED BRONZE | AB



J-1250-AB



J-7012-AB



J-7027-AB

J-1250

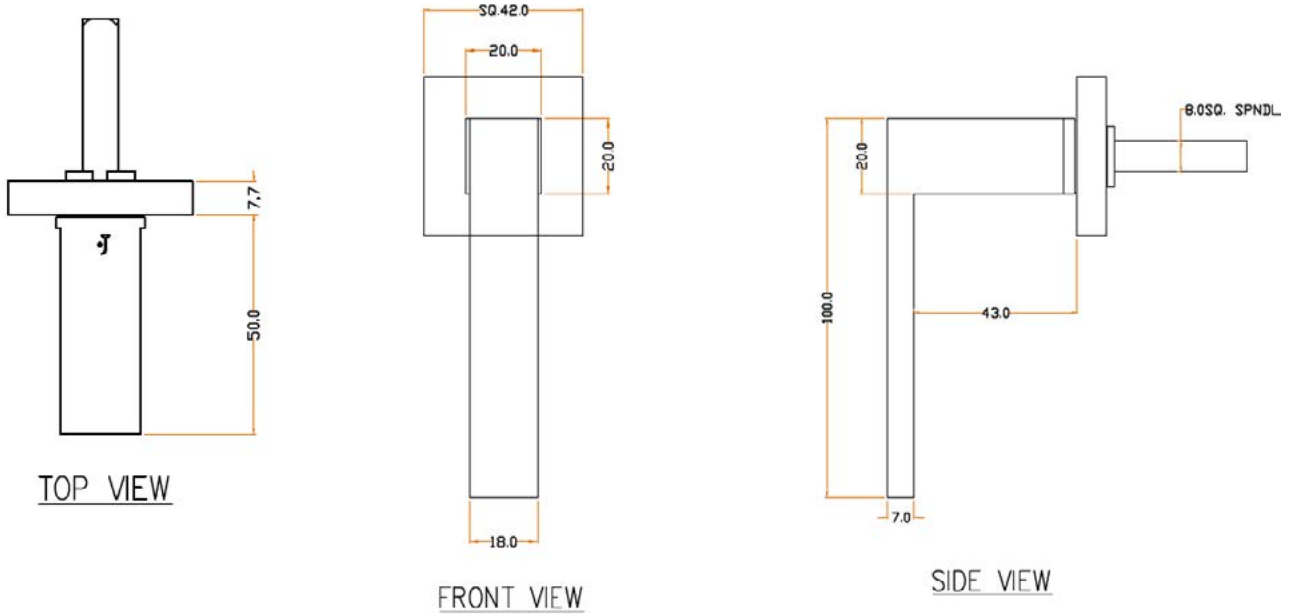

J-7011

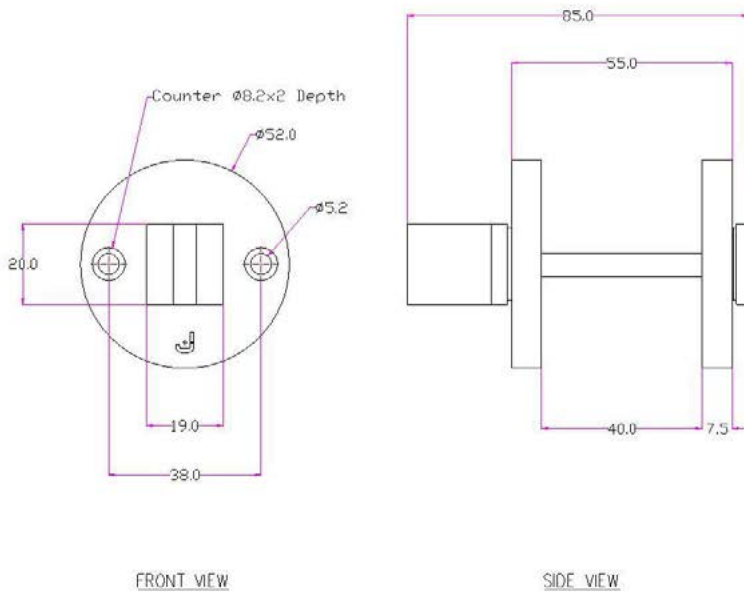

J-7029

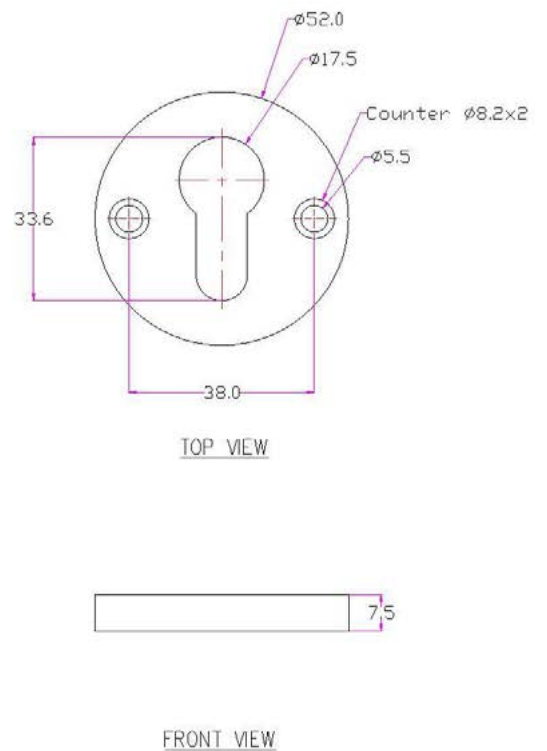

POLARIS 2XT

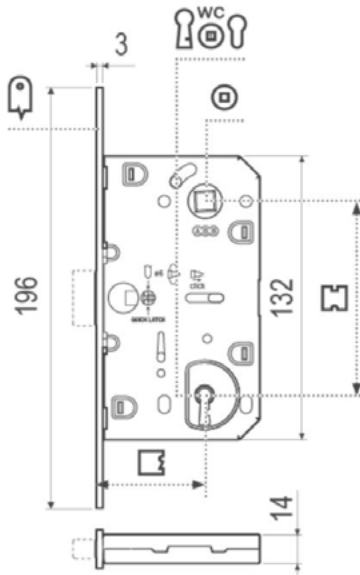

50mm Backset

6mm Passage / Bathroom B06102.50.XX

REVOLUTION XT

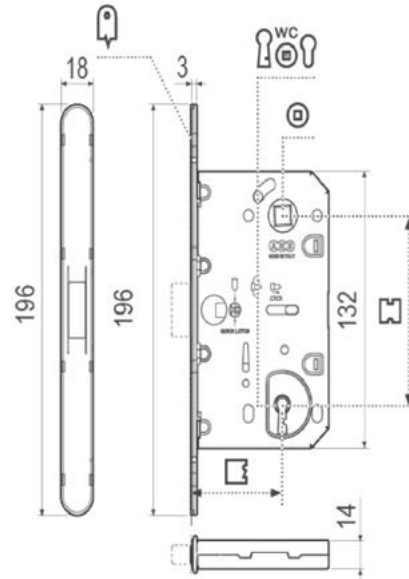

60mm Backset

Euro Cylinder B01109.60.01
6mm Passage / Bathroom B01108.60.01

SICUREZZA 2.0

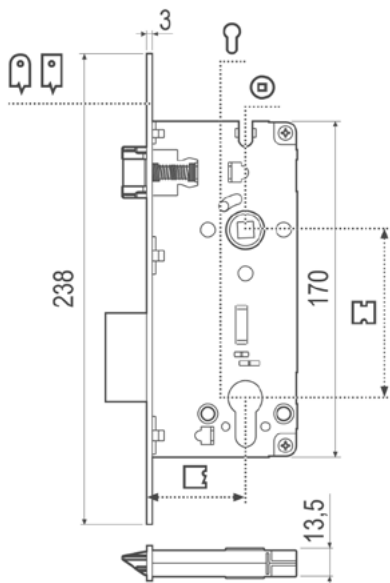

50mm Backset

Euro Cylinder B80851.50.XX

MEDIANA EVOLUTION

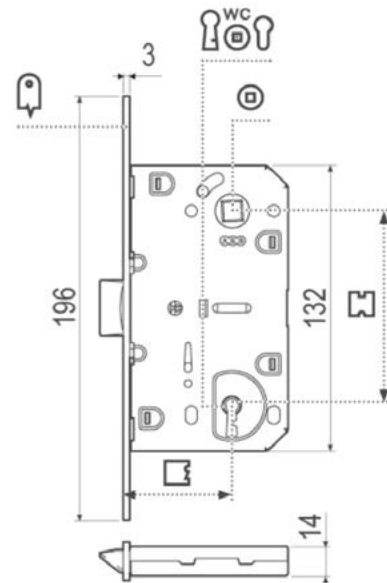

















50mm Backset

Euro Cylinder B01103.50.XX
6mm Passage / Bathroom B01102.50.XX

FINISHES

Replace the XX in the product code on pg.6 with desired finish / number listed below

			Polaris 2XT		
Nickel Plate 06		Enameled Brass 03		Matt Black 93	
Matt Chrome 34		Satin Nickel 13		Antique Brass 12	
ZAMAK STEEL 01			Revolution XT		
			Sicurezza 2.0		
Nickel Plate 06		Enameled Brass 03		Matt Black 93	
Matt Chrome 34		Enameled Bronze 22			
			Mediana Evolution		
Nickel Plate 06		Enameled Brass 03		Matt Black 93	
Matt Chrome 34		Antique Brass 12			

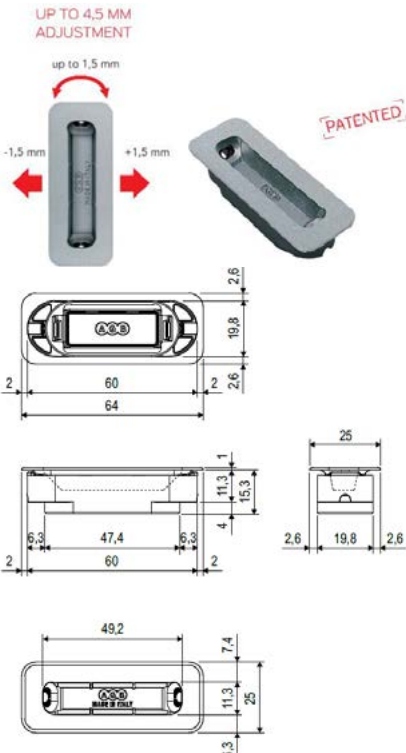
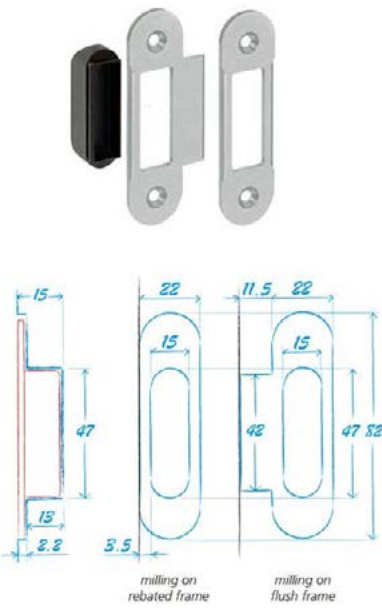
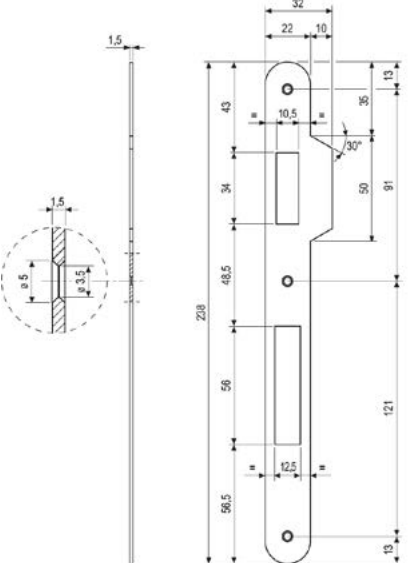
MINIMAL PLUS XT Adjustable Magnetic STRIKER B02402.28.XX	Easy-Matic Striker B01402.90.XX	Sicurezza 2.0 Striker Plate B00590.11.XX
 <p>UP TO 4.5 MM ADJUSTMENT</p> <p>up to 1.5 mm</p> <p>-1.5 mm</p> <p>+1.5 mm</p> <p>PATENTED</p>	 <p>milling on rebated frame</p> <p>milling on flush frame</p>	

Finishes incl: 03 | 06 | 12 | 13 | 34 | 93

Models: LT843

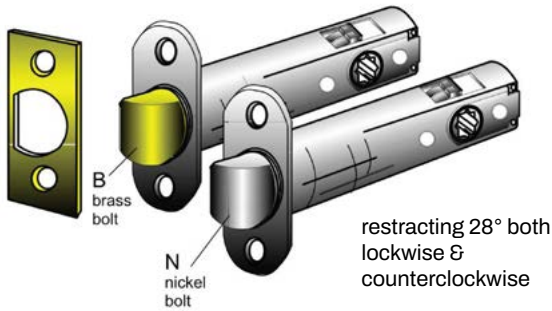

Models L T843 Tubular Latch has a unique design - requiring only 28 degrees, both clockwise and counter-clockwise rotations on either side to retract the Bolt.

The forged solid brass Bolt is reversible to facilitate door handing; supplied with satin brass "B" or satin nickel "N" finishes.

The housing features with a pair of 38mm center to center holes, allowing trim / rosette through bolting mount horizontally. The 28 degree short retracting Latches are assembled with Knob strength only. Power Pack (L T-RS150) or a similar assist spring cage on each side is recommended for Lever application if the lever is of heavy construction/weight.

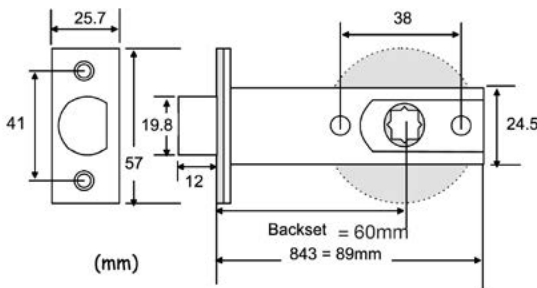

HUB SIZE: 8.0mm² | 7.3mm Diamond

FINISHES: 10B Oil Rubbed Bronze
15 Satin Nickel
3 Bright Brass



Universal Hub 8mm on square & 7.3mm on diamond

LATCHES

Stock No.	Backset	Function	Retracting
LT843KS8B-10B	60mm	Passage	28°
LT843KS8N-15	60mm	Passage	28°
LT843KS8B-3	60mm	Passage	28°



Furnished with Faceplate, LTST-182 'T' Strike, mounting screws and Dust Box as standard

BOLTS

Stock No.	Backset	Function
LT783MB-10B	60mm	Passage
LT783MB-15	60mm	Passage
LT783MB-3	60mm	Passage



LT-RS150
Power pack is recommended when a pair of heavy Lever is applied

MATCHING PRIVACY BOLTS

Models: LT783

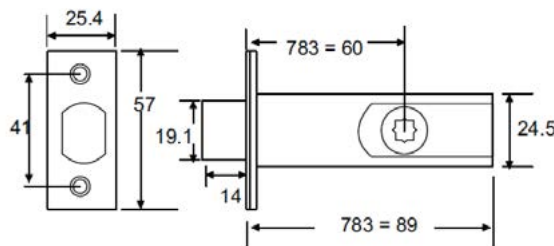
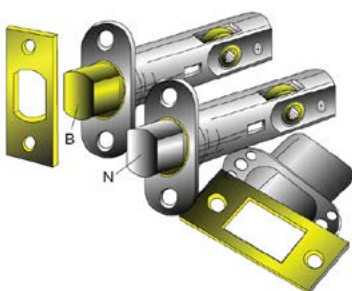

Star hub 5mm on square and diamond

FINISHES:
Oil Rubbed Bronze 10B
Satin Nickel 15
Bright Brass 3

MORTICE LATCH

JACKSON

Models:	JM60	Mortice Latch	Passage
	JMCL60	Mortice Lock	
	JMCL60PV	Mortice Privacy Lock	

JM60

JMCL60

JMCL60PV



Material	Case: Galvanneal Pins: Brass Kits: Brass or Stainless Steel Bolts: Brass
-----------------	---

Finishes	FBU Florentine Bronze Unpolished MB Matt Black SB Satin Brass SCP Satin Chrome Plated SN Satin Nickel*
-----------------	---

*Only available for JM60

		Backset	Hub	
Dimensions (mm)	JM60	22 x 112.5	60	8
	JMCL60	23 x 205	60	8
	JMCL60PV	23 x 205	60	6.5

Square Forend

Contact us for rebate door setups.