

# HINGE TEMPLATE

FOR: AGB ECLIPSE  
ARGENTA INVISIBLE  
NEO CONCEALED HINGES

Fast and efficient installation using  
247 Wood Router Jigs

## What?

The template frame sets up the position of the hinges on the door & frame allowing for consistent measurements. The various model templates slot into this frame including concealed hinges and FORMANI 89 x 89 butt hinges.

## Easy and Fast

These invisible hinge mills are made from a quality technical plastic and can be used loosely as well as on a rail. By means of a steel insert you can fill in both the deepened part and the sight part in a fixture, this saves time and reduces the chance of errors.

---



**TT** | TWO TEASE  
ARCHITECTURAL HARDWARE

22/76 Reserve RD, ARTARMON 2065  
T: 02 9437 9876  
E: [info@twotease.com.au](mailto:info@twotease.com.au)





**247WOOD**

**Product Specific Router Templates**

Choose corresponding template with AGB or ARGENTA product



PRODUCT CODE	PICTURE	DESCRIPTION	RRP Inc GST
1168		Router Template AGB Eclipse 3 INOC 115 x 23	\$91.52
1162		Router Template Argenta NEO-SS 120 x 25	\$91.52
1817		Router Template Argenta NEO-L7 170 x 32	\$91.52

**Butt Hinge Templates**



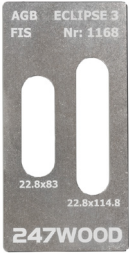

PRODUCT CODE	PICTURE	DESCRIPTION	RRP Inc GST
863		European Butt Hinge Template 89 x 89 left	\$107.69
864		European Butt Hinge Template 89 x 89 right	\$107.69
860		European Butt Hinge Template 76 x 76 left	\$107.69
859		European Butt Hinge Template 76 x 76 right	\$107.69

**These components allow the installation of the listed concealed hinges.**

**AGB ECLIPSE 3.2**

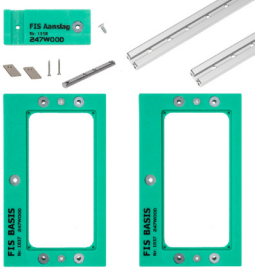
<p><b>1</b> Router Template FIS Basis Set</p>	<p><b>2</b> Router Template for AGB Eclipse 3.2</p>	<p><b>3</b> Router Guide Bush</p>	<p><b>4</b> Groove Cutter</p>
	 <p>Two are required</p>	 <p>Matching router guide bush to hinge</p>	

**ARGENTA INVISIBLE NEO**

<p><b>1</b> Router Template FIS Basis Set</p>	<p><b>2</b> Router Template for ARGENTA Invisible NEO</p>	<p><b>3</b> Router Guide Bush</p>	<p><b>4</b> Groove Cutter</p>
	 <p>Two are required</p>	 <p>Matching router guide bush to hinge</p>	







When ordering the door kit (1261) , it comes with a standard of two hinge templates and you need to order the inserts (templates for the correct hinge E.g. 1192 for AGB Eclipse 3.2 Hinge.

Order additional routing hinge template (1037) for doors that have more than 2 hinges.

**Collared Router Guide Bush**



Choose ONE router that matches with jig

PRODUCT CODE	PICTURE	DESCRIPTION	RRP Inc GST
591		Makita Model <b>3000/RP</b>	\$47.30
595		Makita Model <b>RP0910/1110C</b>	\$52.02
594		DeWalt Model <b>DE6924</b>	\$69.08
596		Festool Model <b>900/1000/1010</b>	\$48.20



**Groove Cutter**

Choose ONE cutter that matches with jig

With 8mm shaft

PRODUCT CODE	PICTURE	DESCRIPTION	RRP Inc GST
1089		Ø 18 mm x Length <b>59</b> mm Carbide	\$104.06
1078		Ø 18 mm x Length <b>70</b> mm Carbide	\$117.48
1175		Wavecutter Drill Ø 18 mm x Length <b>90</b> mm Carbide <b>NOT FOR USE WITH ROUTER</b>	\$81.51

**Router Templates**

PRODUCT CODE	PICTURE	DESCRIPTION	RRP Inc GST
1261		<b>Concealed Hinges Router Template Kit Holder</b> FIS Basis set includes: two template frames, aluminium full length rod & stop block	\$520.30
1242		Router Template Set Transport Bag	\$54.45
1037		Additional Router Template for kit FIS Basis	\$158.95

**DISTRIBUTED BY**

---

**TT** | **TWO TEASE**  
ARCHITECTURAL HARDWARE

22/76 Reserve RD, ARTARMON 2065

T: 02 9437 9876

E: [info@twotease.com.au](mailto:info@twotease.com.au)