

BOBBY EK500 NP

solid pull handle
concealed fixing
stainless steel

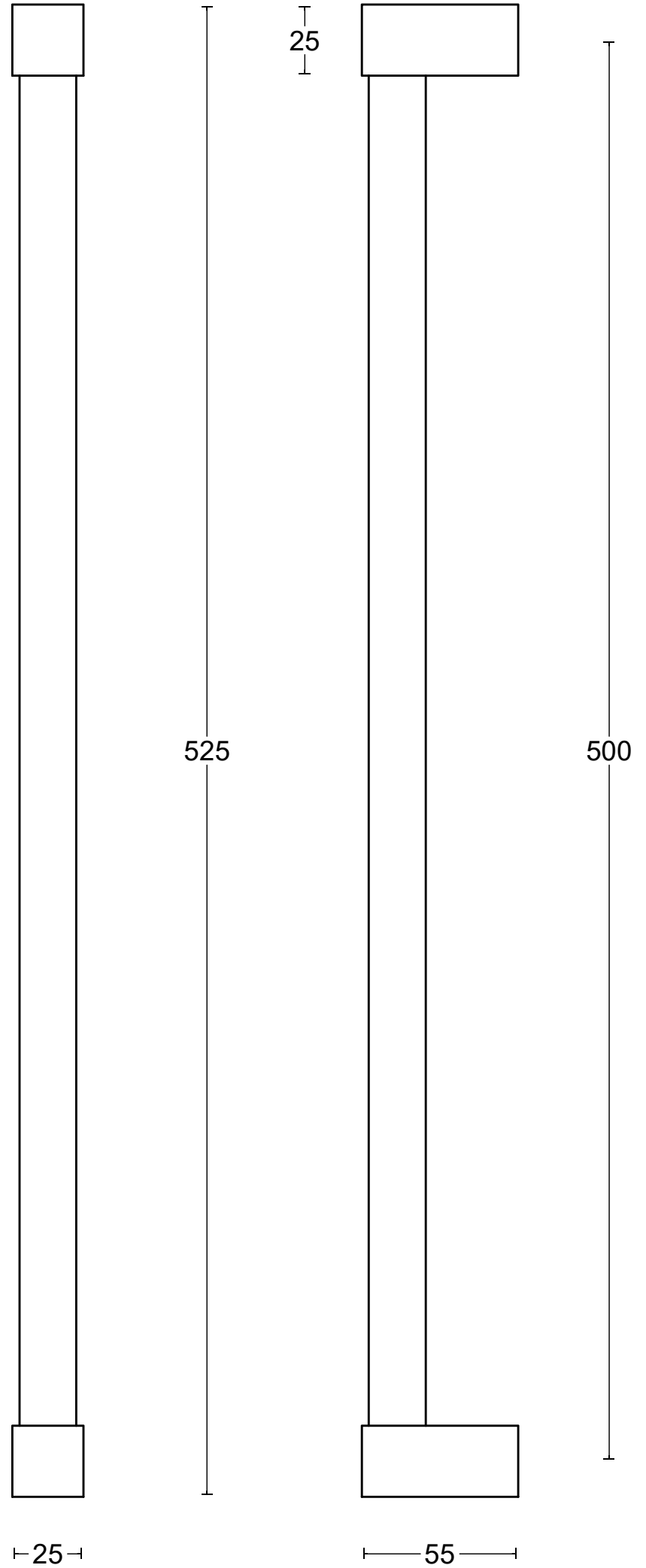
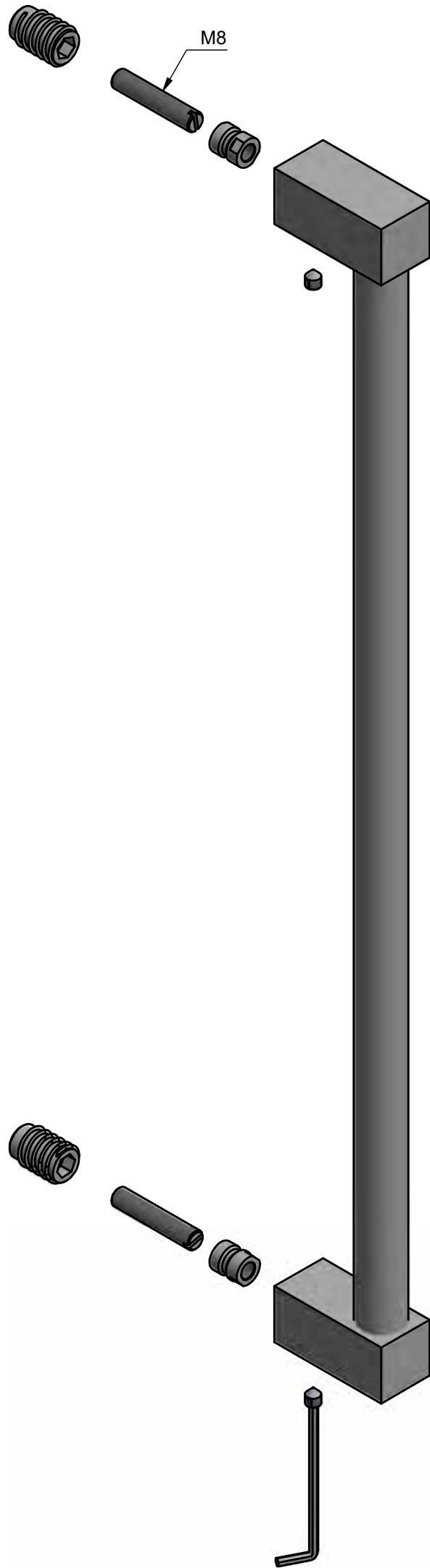

BOBBY EK500 PS

solid pull handle
bolt through fixation
stainless steel

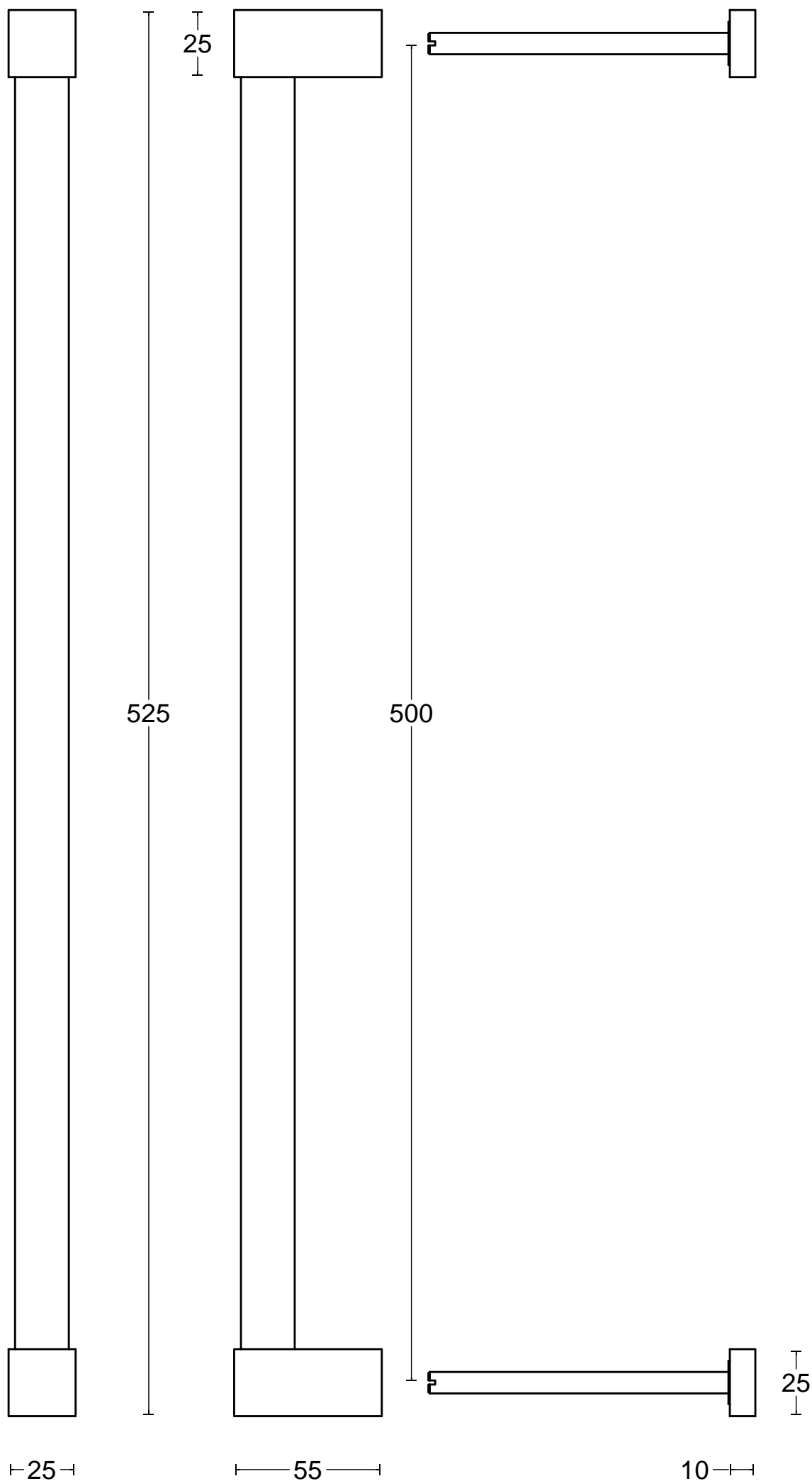
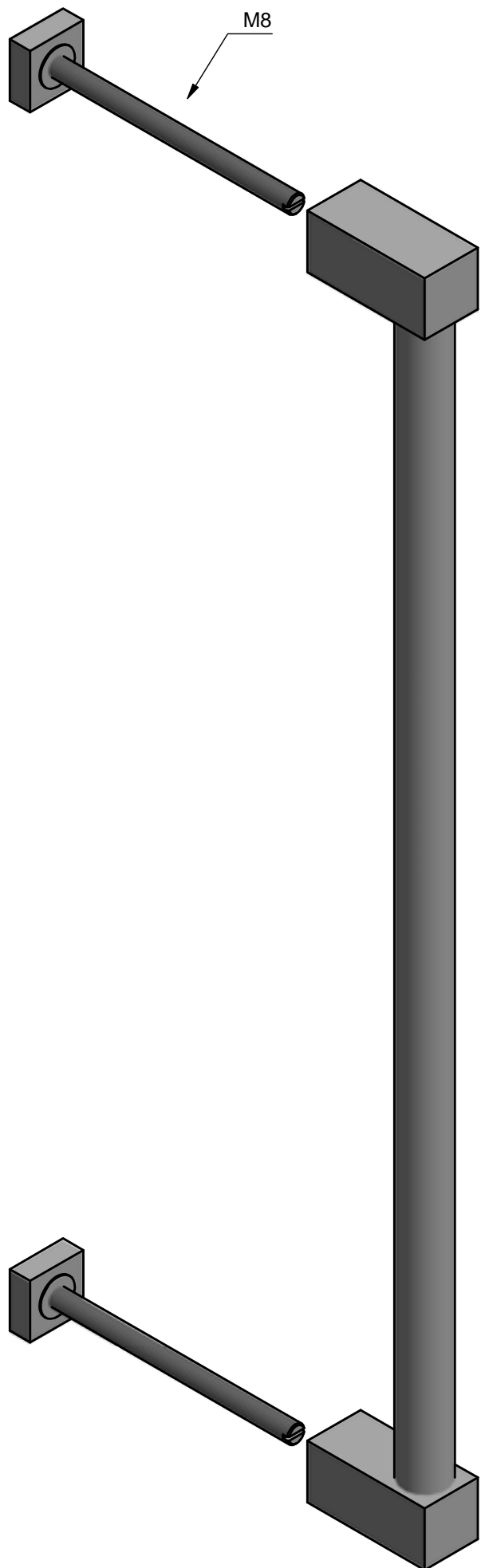

	FORMANI HOLLAND B.V. EUROPALAAN 12 6199 AB MAASTRICHT-AIRPORT NL T +31 (0)43 308 90 00 INFO@FORMANI.COM WWW.FORMANI.COM	Type :	Version:
	Formani filename: 4001G001_2_EK500-PS_V01.dwg	BOBBY EK500 PS	
	Drawn by: Christian Brimbois	Description: solid pull handle bolt through fixation stainless steel	Format A3
Creation date: 20-5-2021			

BOBBY EK500 PA

solid pull handle
back to back fixing
stainless steel

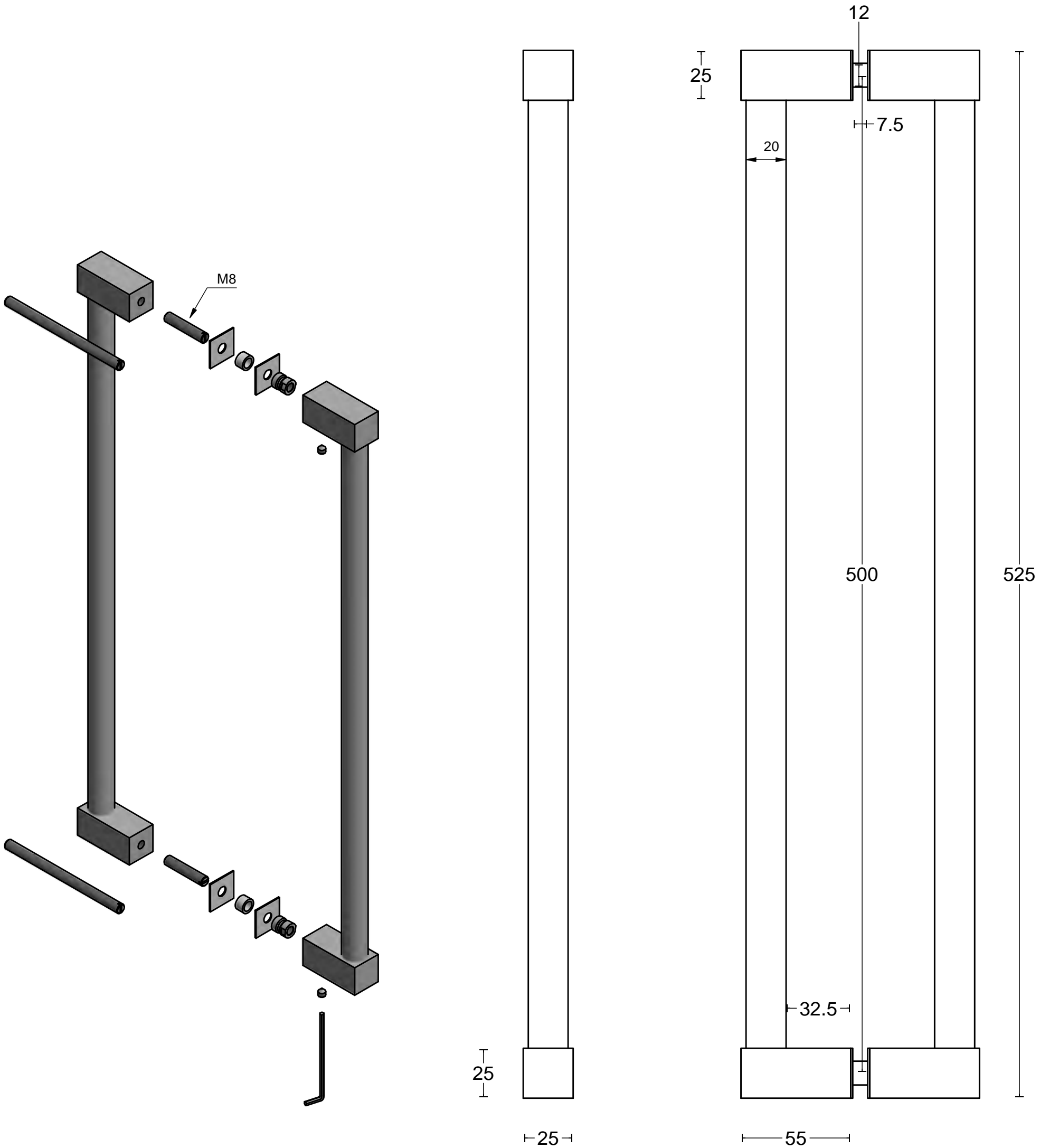

	FORMANI HOLLAND B.V. EUROPALAAN 12 6199 AB MAASTRICHT-AIRPORT NL T +31 (0)43 308 90 00 INFO@FORMANI.COM WWW.FORMANI.COM	Type :	Version:
	Formani filename: 4001G001_3_EK500-PA_V01.dwg	BOBBY EK500 PA	
	Drawn by: Christian Brimbois	Description: solid pull handle back to back fixing stainless steel	Format A3
Creation date: 20-5-2021			